

The University of the State of New York
REGENTS HIGH SCHOOL EXAMINATION

GEOMETRY

Thursday, June 23, 2011—9:15 a.m. to 12:15 p.m., only

Student Name: Mr. Sibol

School Name: HSCR

Print your name and the name of your school on the lines above. Then turn to the last page of this booklet, which is the answer sheet for Part I. Fold the last page along the perforations and, slowly and carefully, tear off the answer sheet. Then fill in the heading of your answer sheet.

This examination has four parts, with a total of 38 questions. You must answer all questions in this examination. Write your answers to the Part I multiple-choice questions on the separate answer sheet. Write your answers to the questions in Parts II, III, and IV directly in this booklet. All work should be written in pen, except graphs and drawings, which should be done in pencil. Clearly indicate the necessary steps, including appropriate formula substitutions, diagrams, graphs, charts, etc.

The formulas that you may need to answer some questions in this examination are found at the end of the examination. This sheet is perforated so you may remove it from this booklet.

Scrap paper is not permitted for any part of this examination, but you may use the blank spaces in this booklet as scrap paper. A perforated sheet of scrap graph paper is provided at the end of this booklet for any question for which graphing may be helpful but is not required. You may remove this sheet from this booklet. Any work done on this sheet of scrap graph paper will *not* be scored.

When you have completed the examination, you must sign the statement printed at the end of the answer sheet, indicating that you had no unlawful knowledge of the questions or answers prior to the examination and that you have neither given nor received assistance in answering any of the questions during the examination. Your answer sheet cannot be accepted if you fail to sign this declaration.

Notice...

A graphing calculator, a straightedge (ruler), and a compass must be available for you to use while taking this examination.

The use of any communications device is strictly prohibited when taking this examination. If you use any communications device, no matter how briefly, your examination will be invalidated and no score will be calculated for you.

DO NOT OPEN THIS EXAMINATION BOOKLET UNTIL THE SIGNAL IS GIVEN.

Part I

Answer all 28 questions in this part. Each correct answer will receive 2 credits. No partial credit will be allowed. For each question, write on the separate answer sheet the numeral preceding the word or expression that best completes the statement or answers the question. [56]

Use this space for computations.

1 Line segment AB is shown in the diagram below.

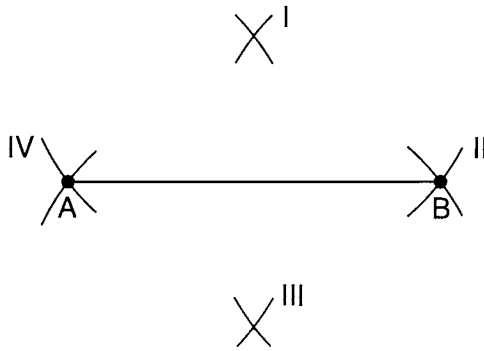

Which two sets of construction marks, labeled I, II, III, and IV, are part of the construction of the perpendicular bisector of line segment AB ?

- (1) I and II
- (2) I and III
- (3) II and III
- (4) II and IV

2 If $\triangle JKL \cong \triangle MNO$, which statement is always true?

- (1) $\angle KLJ \cong \angle NMO$
- (2) $\angle KJL \cong \angle MON$
- (3) $\overline{JL} \cong \overline{MO}$
- (4) $\overline{JK} \cong \overline{ON}$

Use this space for
computations.

- 3 In the diagram below, $\triangle A'B'C'$ is a transformation of $\triangle ABC$, and $\triangle A''B''C''$ is a transformation of $\triangle A'B'C'$.

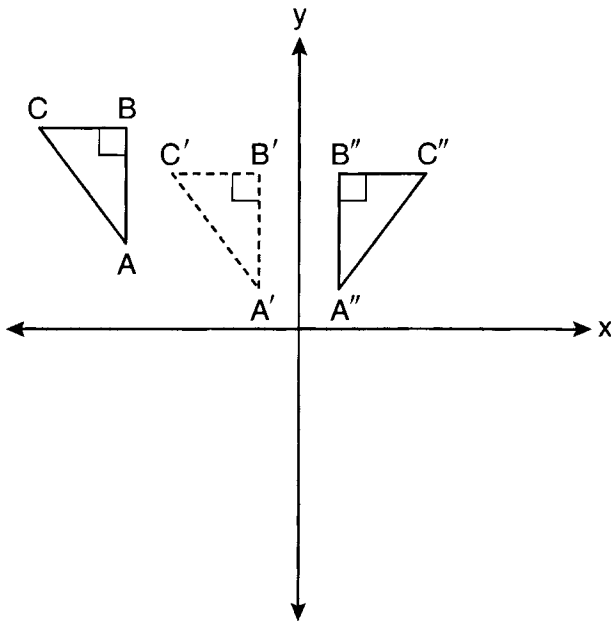

The composite transformation of $\triangle ABC$ to $\triangle A''B''C''$ is an example of a

- (1) reflection followed by a rotation
- (2) reflection followed by a translation
- (3) translation followed by a rotation
- (4) translation followed by a reflection

Use this space for computations.

- 4 In the diagram below of $\triangle ACE$, medians \overline{AD} , \overline{EB} , and \overline{CF} intersect at G . The length of \overline{FG} is 12 cm.

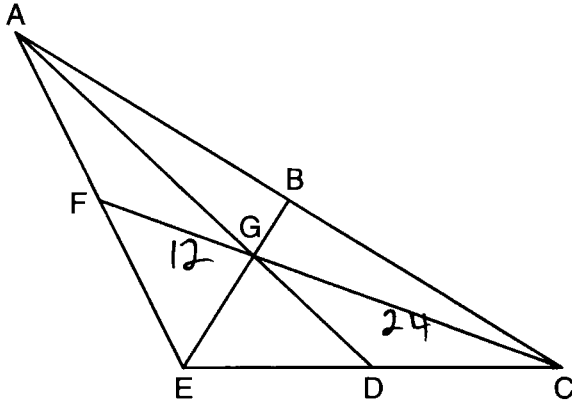

What is the length, in centimeters, of \overline{GC} ?

- (1) 24 (3) 6
 (2) 12 (4) 4

- 5 In the diagram below of circle O , chord \overline{AB} is parallel to chord \overline{CD} .

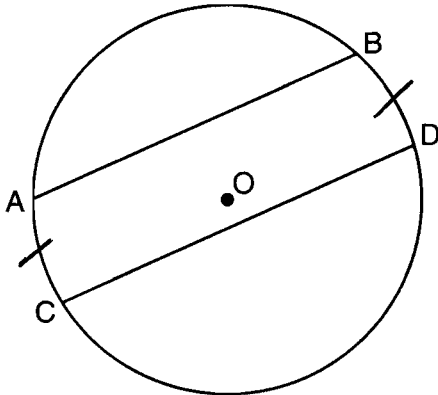

Which statement must be true?

- (1) $\overline{AC} \cong \overline{BD}$ (3) $\overline{AB} \cong \overline{CD}$
 (2) $\overline{AB} \cong \overline{CD}$ (4) $\overline{ABD} \cong \overline{CDB}$

6 In the diagram below, line p intersects line m and line n .

Use this space for
computations.

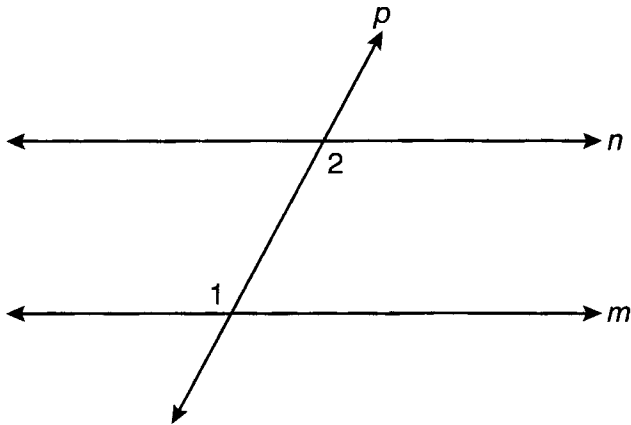

$$\begin{aligned}7x &= 5x + 30 \\2x &= 30 \\x &= 15\end{aligned}$$

If $m\angle 1 = 7x$ and $m\angle 2 = 5x + 30$, lines m and n are parallel when x equals

(1) 12.5

(3) 87.5

(2) 15

(4) 105

7 In the diagram of $\triangle KLM$ below, $m\angle L = 70$, $m\angle M = 50$, and \overline{MK} is extended through N .

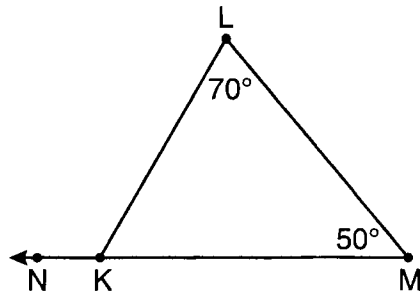

What is the measure of $\angle LKN$?

(1) 60°

(3) 180°

(2) 120°

(4) 300°

Use this space for computations.

8 If two distinct planes, \mathcal{A} and \mathcal{B} , are perpendicular to line c , then which statement is true?

- (1) Planes \mathcal{A} and \mathcal{B} are parallel to each other.
- (2) Planes \mathcal{A} and \mathcal{B} are perpendicular to each other.
- (3) The intersection of planes \mathcal{A} and \mathcal{B} is a line parallel to line c .
- (4) The intersection of planes \mathcal{A} and \mathcal{B} is a line perpendicular to line c .

9 What is the length of the line segment whose endpoints are

$A(-1,9)$ and $B(7,4)$?

- (1) $\sqrt{61}$
- (2) $\sqrt{89}$

- (3) $\sqrt{205}$
- (4) $\sqrt{233}$

$$\begin{aligned} & \sqrt{(-1-7)^2 + (9-4)^2} \\ & \sqrt{64 + 25} \\ & \sqrt{89} \end{aligned}$$

10 What is an equation of circle O shown in the graph below?

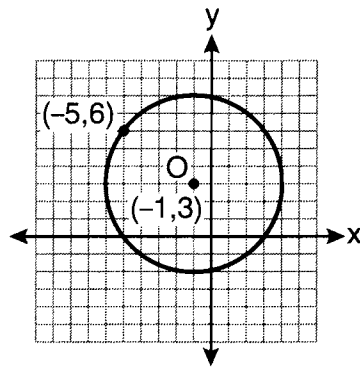

- (1) $(x + 1)^2 + (y - 3)^2 = 25$
- (2) $(x - 1)^2 + (y + 3)^2 = 25$
- (3) $(x - 5)^2 + (y + 6)^2 = 25$
- (4) $(x + 5)^2 + (y - 6)^2 = 25$

Use this space for computations.

- 11 In the diagram below, parallelogram $ABCD$ has diagonals \overline{AC} and \overline{BD} that intersect at point E .

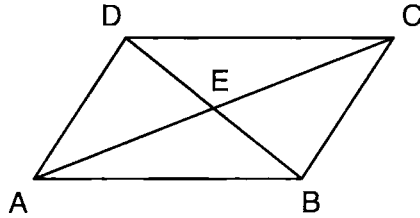

Which expression is *not* always true?

- (1) $\angle DAE \cong \angle BCE$ (3) $\overline{AC} \cong \overline{DB}$
(2) $\angle DEC \cong \angle BEA$ (4) $\overline{DE} \cong \overline{EB}$

- 12 The volume, in cubic centimeters, of a sphere whose diameter is 6 centimeters is

- (1) 12π (3) 48π
(2) 36π (4) 288π

$$V = \frac{4}{3} \pi \cdot 3^3 \\ = 36\pi$$

- 13 The equation of line k is $y = \frac{1}{3}x - 2$. The equation of line m is $-2x + 6y = 18$. Lines k and m are

- (1) parallel $m = \frac{-A}{B} = \frac{2}{6} = \frac{1}{3}$
(2) perpendicular
(3) the same line
(4) neither parallel nor perpendicular

Use this space for computations.

14 What are the center and the radius of the circle whose equation is $(x - 5)^2 + (y + 3)^2 = 16$?

- (1) $(-5, 3)$ and 16 (3) $(-5, 3)$ and 4
(2) $(5, -3)$ and 16 (4) $(5, -3)$ and 4

15 Triangle ABC has vertices $A(0,0)$, $B(3,2)$, and $C(0,4)$. This triangle may be classified as

- (1) equilateral (3) right
(2) isosceles (4) scalene

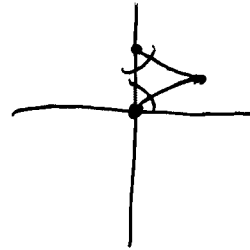

16 In rhombus $ABCD$, the diagonals \overline{AC} and \overline{BD} intersect at E . If $AE = 5$ and $BE = 12$, what is the length of \overline{AB} ?

- (1) 7 (3) 13
(2) 10 (4) 17

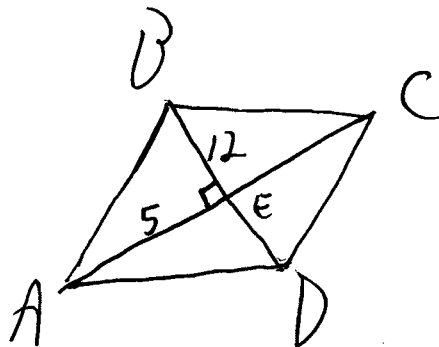

$$\sqrt{12^2 + 5^2} = \sqrt{169} = 13$$

Use this space for computations.

- 17 In the diagram below of circle O , \overline{PA} is tangent to circle O at A , and \overline{PBC} is a secant with points B and C on the circle.

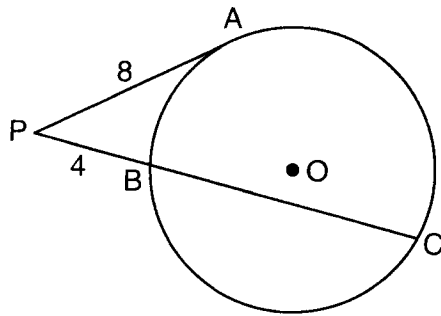

$$4(x+4) = 8^2$$

$$4x + 16 = 64$$

$$4x = 48$$

$$x = 12$$

If $PA = 8$ and $PB = 4$, what is the length of \overline{BC} ?

- (1) 20
 (2) 16
 (3) 15
 (4) 12

- 18 Lines m and n intersect at point A . Line k is perpendicular to both lines m and n at point A . Which statement *must* be true?

- (1) Lines m , n , and k are in the same plane.
 (2) Lines m and n are in two different planes.
 (3) Lines m and n are perpendicular to each other.
 (4) Line k is perpendicular to the plane containing lines m and n .

- 19 In $\triangle DEF$, $m\angle D = 3x + 5$, $m\angle E = 4x - 15$, and $m\angle F = 2x + 10$. Which statement is true?

- (1) $DF = FE$
 (2) $DE = FE$
 (3) $m\angle E = m\angle F$
 (4) $m\angle D = m\angle F$

$$3x + 5 + 4x - 15 + 2x + 10 = 180$$

$$9x = 180$$

$$x = 20$$

Use this space for computations.

- 20 As shown in the diagram below, $\triangle ABC \sim \triangle DEF$, $AB = 7x$, $BC = 4$, $DE = 7$, and $EF = x$.

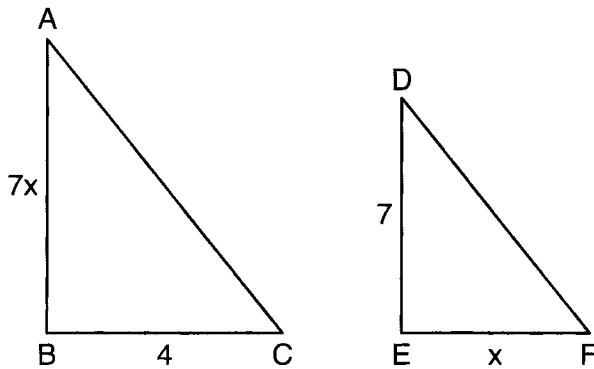

$$\frac{7x}{4} = \frac{7}{x}$$

$$7x^2 = 28$$

$$x^2 = 4$$

$$x = 2$$

What is the length of \overline{AB} ?

- (1) 28
 (2) 2
 (3) 14
 (4) 4
- 21 A man wants to place a new bird bath in his yard so that it is 30 feet from a fence, f , and also 10 feet from a light pole, P . As shown in the diagram below, the light pole is 35 feet away from the fence.

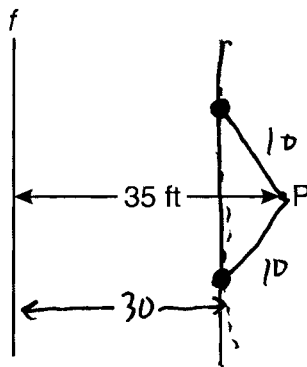

How many locations are possible for the bird bath?

- (1) 1
 (2) 2
 (3) 3
 (4) 0

Use this space for computations.

- 22 As shown on the graph below, $\triangle R'S'T'$ is the image of $\triangle RST$ under a single transformation.

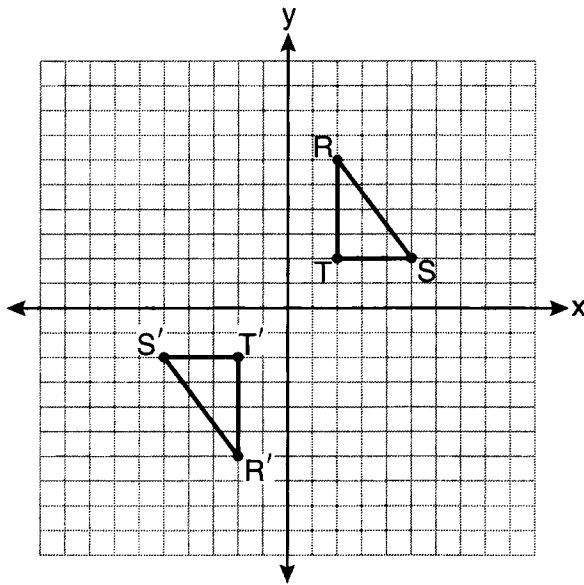

Which transformation does this graph represent?

- (1) glide reflection (3) rotation
 (2) line reflection (4) translation

- 23 Which line is parallel to the line whose equation is $4x + 3y = 7$ and also passes through the point $(-5, 2)$?

- (1) $4x + 3y = -26$ (3) $3x + 4y = -7$
 (2) $4x + 3y = -14$ (4) $3x + 4y = 14$

$$M = \frac{-A}{B} = \frac{-4}{3}$$

$$y = \frac{-4}{3}x + \frac{14}{3}$$

$$3y = -4x - 14$$

$$4x + 3y = -14$$

$$y = mx + b$$

$$2 = \frac{-4}{3}(-5) + b$$

$$2 = \frac{+20}{3} + b$$

$$\frac{-14}{3} = b$$

Use this space for
computations.

24 If the vertex angles of two isosceles triangles are congruent, then the triangles must be

- (1) acute
(2) congruent
(3) right
(4) similar

25 Which quadrilateral has diagonals that always bisect its angles and also bisect each other?

- (1) rhombus
(2) rectangle
(3) parallelogram
(4) isosceles trapezoid

26 When $\triangle ABC$ is dilated by a scale factor of 2, its image is $\triangle A'B'C'$. Which statement is true?

- (1) $\overline{AC} \cong \overline{A'C'}$
(2) $\angle A \cong \angle A'$
(3) perimeter of $\triangle ABC =$ perimeter of $\triangle A'B'C'$
(4) $2(\text{area of } \triangle ABC) = \text{area of } \triangle A'B'C'$

Use this space for
computations.

27 What is the slope of a line that is perpendicular to the line whose equation is $3x + 5y = 4$?

(1) $-\frac{3}{5}$

(2) $\frac{3}{5}$

(3) $-\frac{5}{3}$

(4) $\frac{5}{3}$

$$M = \frac{-A}{B} = \frac{-3}{5}$$

$$M_{\perp} = \frac{5}{3}$$

28 In the diagram below of right triangle ABC , altitude \overline{BD} is drawn to hypotenuse \overline{AC} , $AC = 16$, and $CD = 7$.

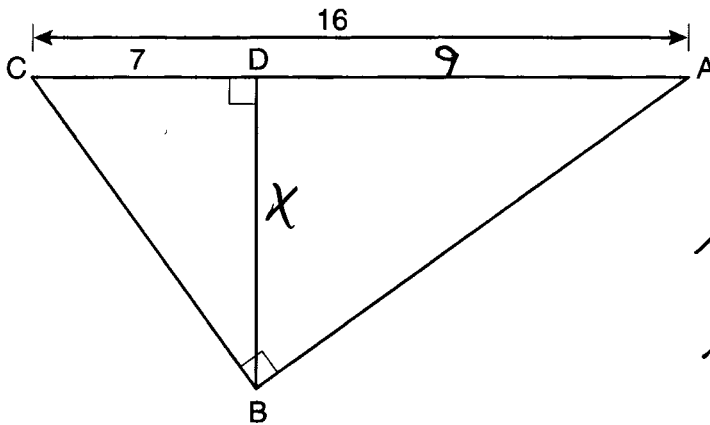

$$x^2 = 9 \cdot 7$$

$$x^2 = 63$$

$$x = \sqrt{63}$$

$$x = \sqrt{9 \cdot 7}$$

$$x = 3\sqrt{7}$$

What is the length of \overline{BD} ?

(1) $3\sqrt{7}$

(2) $4\sqrt{7}$

(3) $7\sqrt{3}$

(4) 12

Part II

Answer all 6 questions in this part. Each correct answer will receive 2 credits. Clearly indicate the necessary steps, including appropriate formula substitutions, diagrams, graphs, charts, etc. For all questions in this part, a correct numerical answer with no work shown will receive only 1 credit. All answers should be written in pen, except for graphs and drawings, which should be done in pencil. [12]

- 29 Given the true statement, "The medians of a triangle are concurrent," write the negation of the statement and give the truth value for the negation.

The medians of a triangle are not concurrent.

False

30 Using a compass and straightedge, on the diagram below of \overleftrightarrow{RS} , construct an equilateral triangle with \overline{RS} as one side. [Leave all construction marks.]

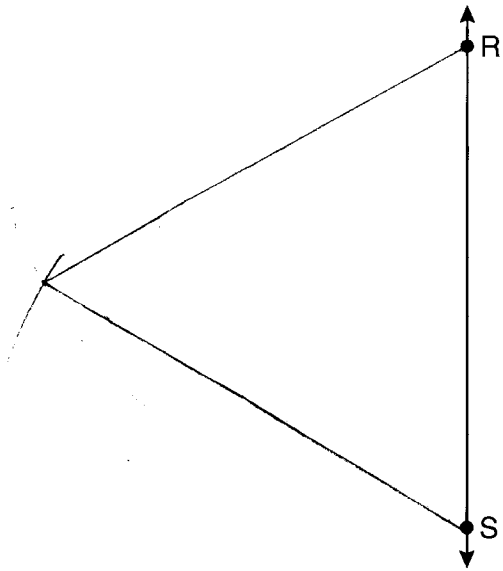

31 The Parkside Packing Company needs a rectangular shipping box. The box must have a length of 11 inches and a width of 8 inches. Find, to the *nearest tenth of an inch*, the minimum height of the box such that the volume is *at least* 800 cubic inches.

$$V = lwh$$

$$800 = 11 \cdot 8 \cdot h$$

$$\frac{800}{88} = h$$

$$9.1 \approx h$$

- 32 A pentagon is drawn on the set of axes below. If the pentagon is reflected over the y -axis, determine if this transformation is an isometry. Justify your answer. [The use of the set of axes below is optional.]

Yes. A reflection is an isometry.

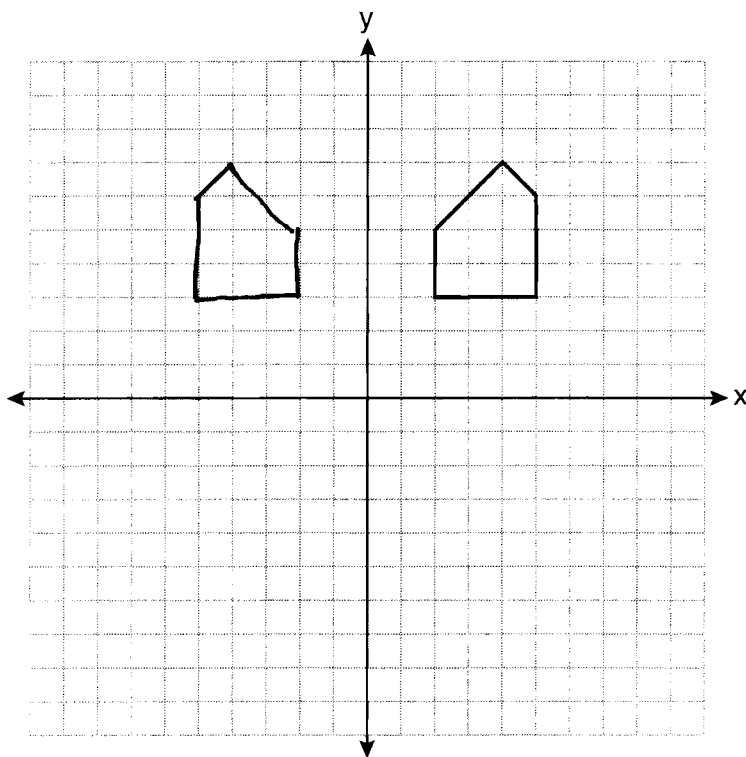

- 33 In the diagram below of $\triangle ABC$, D is a point on \overline{AB} , E is a point on \overline{BC} , $\overline{AC} \parallel \overline{DE}$, $CE = 25$ inches, $AD = 18$ inches, and $DB = 12$ inches. Find, to the nearest tenth of an inch, the length of \overline{EB} .

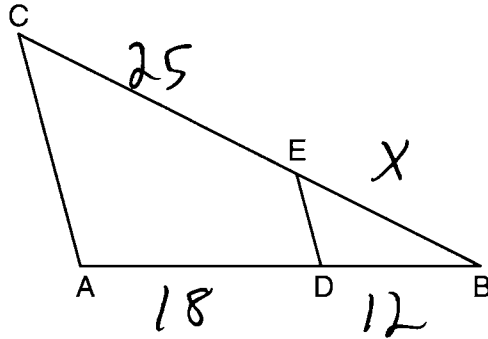

$$\frac{X}{25} = \frac{12}{18}$$

$$\frac{18X}{18} = \frac{300}{18}$$

$$X \approx 16.7$$

34 In circle O , diameter \overline{RS} has endpoints $R(3a, 2b - 1)$ and $S(a - 6, 4b + 5)$. Find the coordinates of point O , in terms of a and b . Express your answer in simplest form.

$$\left(\frac{3a + a - 6}{2}, \frac{2b - 1 + 4b + 5}{2} \right)$$

$$\left(\frac{4a - 6}{2}, \frac{6b + 4}{2} \right)$$

$$(2a - 3, 3b + 2)$$

Part III

Answer all 3 questions in this part. Each correct answer will receive 4 credits. Clearly indicate the necessary steps, including appropriate formula substitutions, diagrams, graphs, charts, etc. For all questions in this part, a correct numerical answer with no work shown will receive only 1 credit. All answers should be written in pen, except for graphs and drawings, which should be done in pencil. [12]

- 35 On the set of coordinate axes below, graph the locus of points that are equidistant from the lines $y = 6$ and $y = 2$ and also graph the locus of points that are 3 units from the y -axis. State the coordinates of *all* points that satisfy *both* conditions.

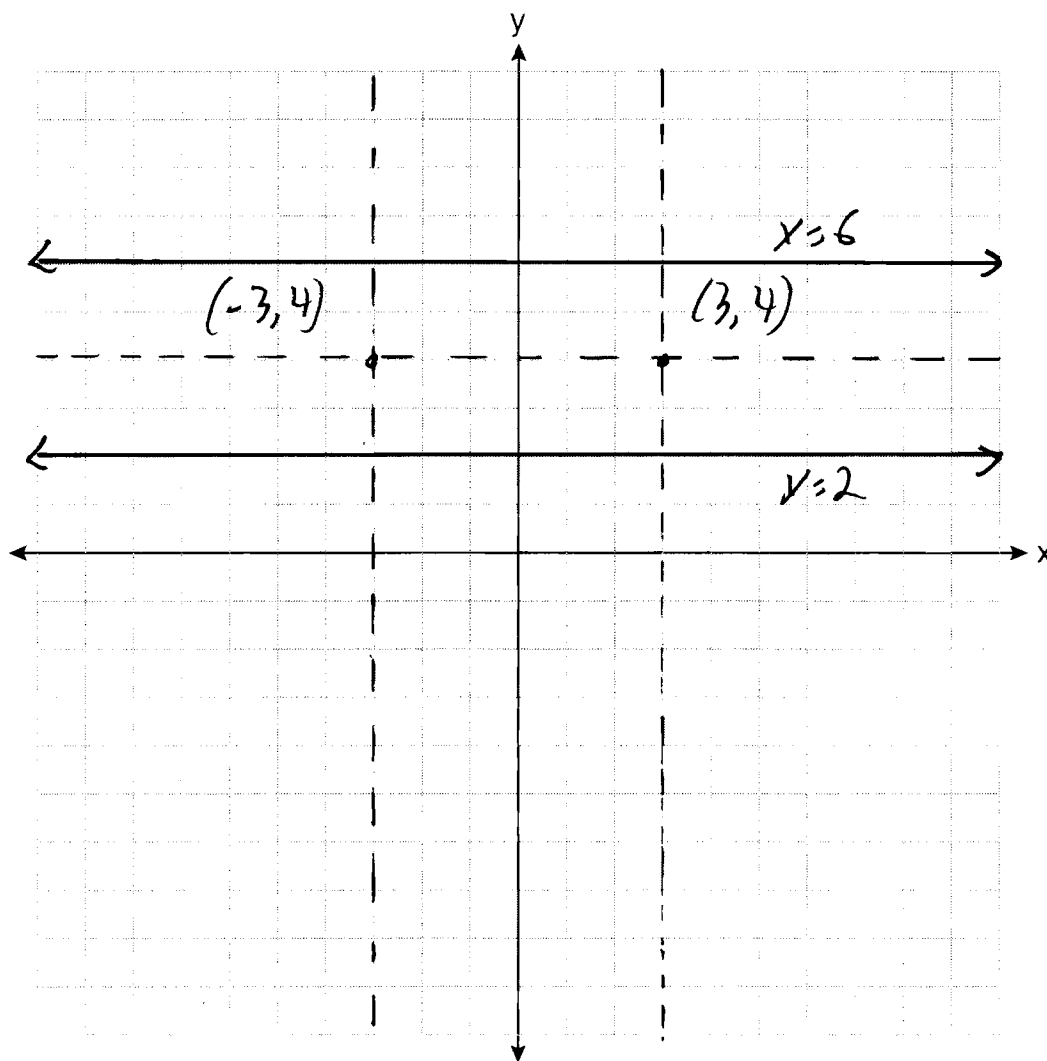

36 In the diagram below, tangent \overline{ML} and secant \overline{MNK} are drawn to circle O .

The ratio $m\widehat{LN}:m\widehat{NK}:m\widehat{KL}$ is 3:4:5. Find $m\angle LMK$.

$$90:120:150$$

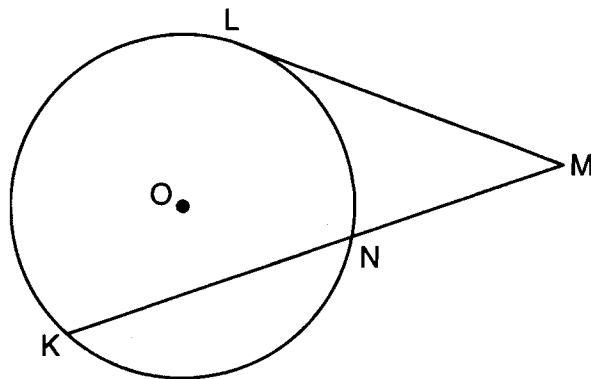

$$3x + 4x + 5x = 360$$

$$12x = 360$$

$$x = 30$$

$$\frac{150 - 90}{2} = \frac{60}{2} = 30$$

37 Solve the following system of equations graphically.

$$2x^2 - 4x = y + 1 \quad y = 2x^2 - 4x - 1$$

$$x + y = 1$$

$$y = -x + 1$$

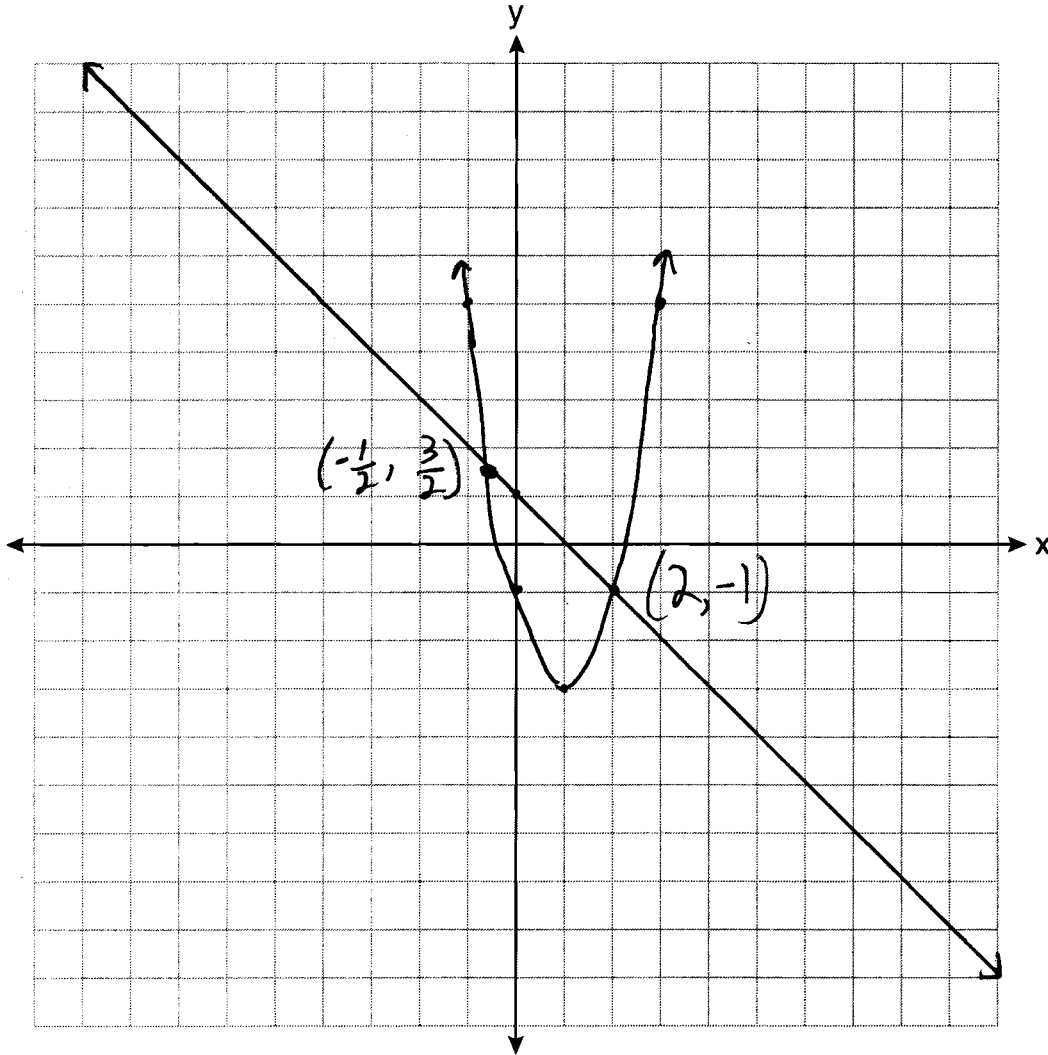

Part IV

Answer the question in this part. A correct answer will receive 6 credits. Clearly indicate the necessary steps, including appropriate formula substitutions, diagrams, graphs, charts, etc. A correct numerical answer with no work shown will receive only 1 credit. The answer should be written in pen. [6]

38 In the diagram below, \overline{PA} and \overline{PB} are tangent to circle O , \overline{OA} and \overline{OB} are radii, and \overline{OP} intersects the circle at C .

Prove: $\angle AOP \cong \angle BOP$

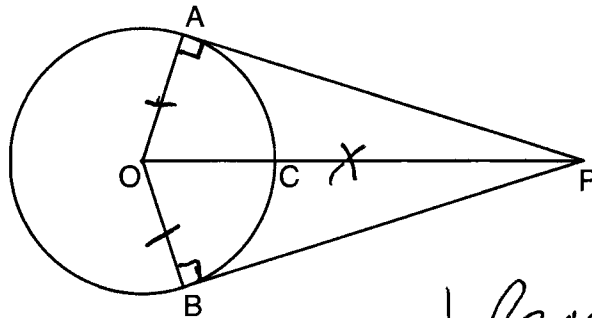

Statement	Reason
① \overline{PA} and \overline{PB} are tangent to circle O , \overline{OA} and \overline{OB} are radii, and \overline{OP} intersects the circle at C .	① Given
② $\overline{OA} \cong \overline{OB}$	② All radii are congruent
③ $\overline{OP} \cong \overline{OP}$	③ Reflexive Property
④ $\overline{OA} \perp \overline{PA}$ and $\overline{OB} \perp \overline{PB}$	④ Tangents to a circle are \perp to a radius at a point on the circle
⑤ $\angle PAO$ and $\angle PBO$ are right angles	⑤ Definition of \perp
⑥ $\angle PAO \cong \angle PBO$	⑥ All right angles are congruent
⑦ $\triangle AOP \cong \triangle BOP$	⑦ HL
⑧ $\angle AOP \cong \angle BOP$	⑧ CPCTC